

■ PRODUCT DATASHEET

Smart Locker Cabinet LUVIO.

Plug & Play Smart Locker Cabinets,
made from wood.

■ PRODUCT DATASHEET

Smart Locker Cabinet LUVIO

High-quality cabinet, featuring reinforced “front-laying” doors, customizable dimensions, and eco-friendly construction. This storage solution is designed for both practicality and durability, making it an excellent choice for various spaces.

Our LUVIO-line is specifically designed and manufactured in Europe. This series is very suitable for installation in offices, cloakrooms, and changing rooms due to their high level of finishing, standard with a sleek white interior and doors. All cabinets stand on a plinth that can be easily adjusted when a set-up is changed.

- Versatile Design, Ideal for Modern Spaces
- “Front-Laying” Doors for Enhanced Safety
- Customizable Dimensions
- Eco-Friendly Construction



Technical Specifications

Our wooden Smart Locker Cabinets are crafted with durability and versatility, offering seamless storage solutions for various environments. Engineered for robust storage solutions, we offer versatile configurations to meet several storage needs.

GENERAL

Compartments	The cabinet can have 1-10 doors per column
Door design	Front laying doors with minimal seams for a modern design
Material cabinet	High-quality MFC board (18 mm)
Material doors	High-quality MFC board (18 mm)
Material base	High-quality MFC board (18 mm)
Half column empty weight	33 - 43 kg
Single column empty weight	45 - 75 kg
Usability	All screws that can be seen by users are TORX
Intended use environment	Indoor

CABINET

Material finish body/doors	Eurodekor, melaminated 100% PEFC - 18 mm melaminated chipboard with side finishing using 2 mm ABS edge-banding
Color body	Standard white
Cabinet texture	Laminate 100% PEFC
Assembly state	Cabinet fully assembled
Compartments	Compartments provided with a lock profile (plastic white) for hidden mounting of the Smart Lock Rene and for safe cable management and mechanical emergency opening
Firegrade	Firegrade D

DOOR

Doors	Eurodekor, melaminated 100% PEFC - 18 mm melaminated chipboard with side finishing using 2 mm ABS edge-banding
Color	See color chart
Door front texture	Laminate 100% PEFC
Opening direction	Right opening
Closing	Doors equipped with a buffer for cushioned closing in combination with robust self-closing hinges with 3-dimensional adjustment
Hinge type (need to select preference)	<ol style="list-style-type: none"> 1. Blum hinge (3D adjustable robust hinge with possibilities for perfect alignment) 2. Keynius Pin hinge (Simple and robust door hinge)
Firegrade	Firegrade D

BASE

Plinth	Cabinet always stands on 200 mm. high plinth which can be opened securely from the front using a master key to provide access to the technical compartment and mechanical emergency opening
--------	---

**DETAILED
SPECIFICATION**



Cabinet connection holes

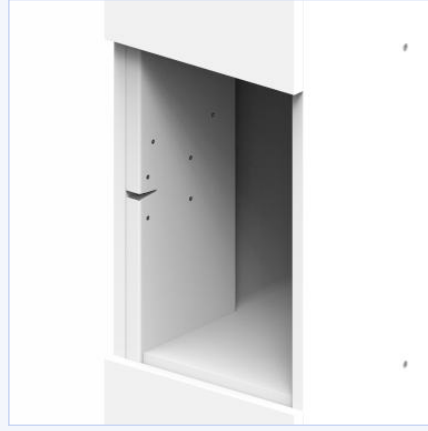

Lock profile



Cylinder lock in base

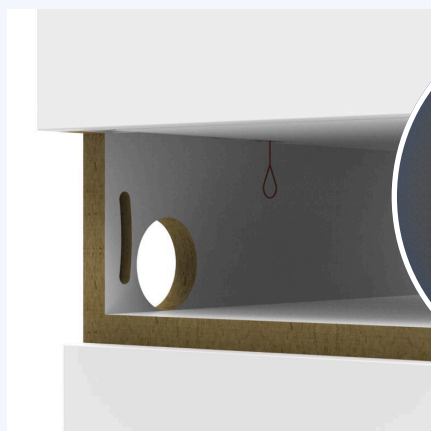
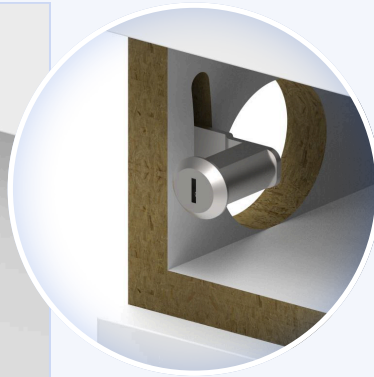

Mechanical emergency opening

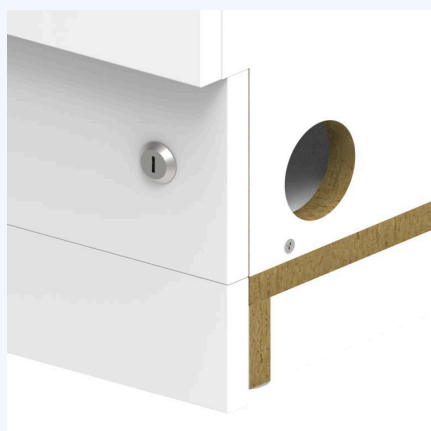

Holes for cable management



Base



Adjustable feet

**REQUIRED HINGE
OPTION**



Blum hinge



Keynius Pin hinge

■ PRODUCT DATASHEET

Locking Technology

Storing personal and company belongings has been very important for many years. Nowadays it is also essential that this can be done quickly, easily, safely, and with due regard for privacy. The storage options are endless and can be fully adapted to the wishes of the users.

Smart Lock René

The game changer in the smart locking industry. Possibility to use as both push2open and pop2open. In case of a power shutdown, the mechanical emergency override will make sure lockers can still be opened.

- 2 ways of cable connection
- Mechanical emergency opening
- Cabinet mount or profile mount
- Push- & Pop2open by software
- Plug & Play
- Easy to install

Smart Home Teacher V3

The compact designed Smart Homes are the backbones of our smart locking system. Easy to install and connect, with up to 16 locks per unit. The Smart Home Teacher is the basis and can control up to 13 Smart Home Students, operating 224 locks in total.

- Plug & Play
- Connect up to 13 Students on 1 teacher
- Open all locks emergency opening
- Connect Smart Lock Rene + Add-ons
- Status LEDs
- LAN



■ PRODUCT DATASHEET



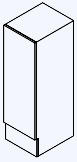
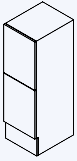
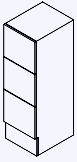
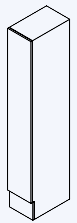
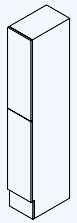
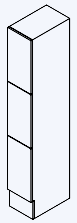

Dimensions

Our wooden locker cabinets are available in a range of sizing options to accommodate diverse storage needs. Select various configurations, with 1-10 doors per column, for tailored storage solutions.

ONE COLUMN

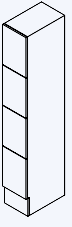
	Column	Lockers	Total height	Internal height per locker*	Width	Internal width per locker*	Depth	Internal depth per locker*
	1	1	1281 mm	1044 mm	300 mm 400 mm	219 mm 319 mm	500 mm	464 mm
	1	2	1281 mm	513mm	300 mm 400 mm	219 mm 319 mm	500 mm	464 mm
	1	3	1281 mm	342 mm	300 mm 400 mm	219 mm 319 mm	500 mm	464 mm
	1	1	2000 mm	1763 mm	300 mm 400 mm	219 mm 319 mm	500 mm	464 mm
	1	2	2000 mm	872 mm	300 mm 400 mm	219 mm 319 mm	500 mm	464 mm
	1	3	2000 mm	582 mm	300 mm 400 mm	219 mm 319 mm	500 mm	464 mm

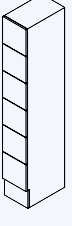
ONE COLUMN

	Column	Lockers	Total height	Internal height per locker*	Width	Internal width per locker*	Depth	Internal depth per locker*
	1	4	2000 mm	432 mm	300 mm 400 mm	219 mm 319 mm	500 mm	464 mm
	1	5	2000 mm	342 mm	300 mm 400 mm	219 mm 319 mm	500 mm	464 mm
	1	6	2000 mm	282 mm	300 mm 400 mm	219 mm 319 mm	500 mm	464 mm
	1	10	2000 mm	162 mm	300 mm 400 mm	219 mm 319 mm	500 mm	464 mm

* Sizes are shown as average sizes and may deviate in real life.

■ PRODUCT DATASHEET

Interior Accessories

Enhance the functionality and customization of your LUVIO Smart Locker Cabinet with our range of accessories.

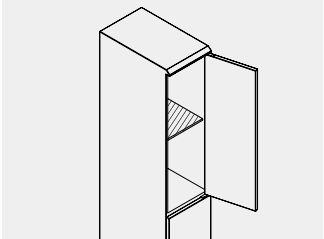

Additional Shelves

Increase storage capacity and organization with durable shelves.

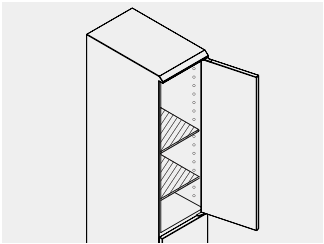

Height Adjustable Shelf

Experience a customizable compartment with height adjustable (white) shelves to increase the storage capacity even more.

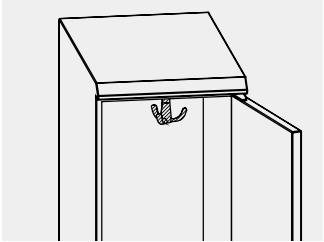

Clothing Hook(s)

Steel functional clothing hook with three hanging points.

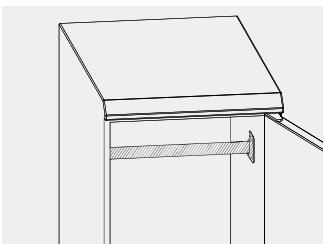

Clothing Rod (20mm)

Steel bar for clothing hangers.

■ PRODUCT DATASHEET

Exterior Accessories

Enhance the functionality and customization of your LUVIO Smart Locker Cabinet with our range of accessories.

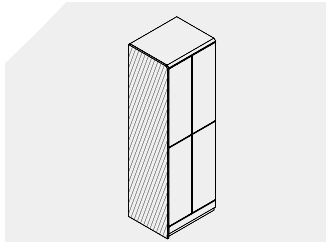

Side Panels (Left and Right)

Finish your cabinets with some aesthetically pleasing side panels to create a unified lockerwall.

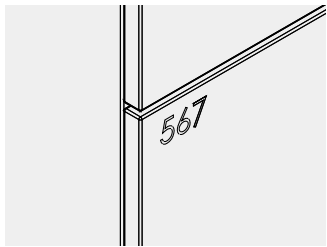

Numbering Sticker

This sticker can be placed directly on the door for simplified locker management. Available in colours: Black, Silver/Gray, and White.

■ PRODUCT DATASHEET

Technology Accessories

Enhance the functionality and customization of your LUVIO Smart Locker Cabinet with our range of accessories.



Smarty 8 Inch Touch Screen

Extensive operating options for a locker, just within reach. This Smarty touch screen offers extensive options for both users and administrators: access via RFID or PIN code and login functionalities and developing scenarios for administrators. The perfect solution if space on the locker is limited.



Smarty 15 Inch Touch Screen

Extensive operating options for a locker, just within reach. This Smarty touch screen offers extensive options for both users and administrators: access via RFID or PIN code and login functionalities and developing scenarios for administrators. The perfect solution if there is a need for a large screen.



Payment Terminal Contactless and PIN

A multifunctional payment terminal that is optimally suited for unattended environments, both indoors and outdoors. This terminal has a camera for scanning barcodes, an antenna for cellular communication and a pre-installed SIM card. This payment terminal allows users to pay quickly and securely with a debit card or mobile wallet.



QR reader IP66

Access control has never been easier thanks to this QR reader. This QR reader can easily be connected to Keynius products with a USB connection. Seamless integration then ensures an optimal user experience for both users and administrators. The IP66 certification makes this QR reader weatherproof and ideal for outdoor use.

Data sheets that are also available:

- Smarty 8 inch
- Smarty 10 inch
- Smarty 15 inch
- Smarty Headless
- RFID Reader panel
- Smart Home Teacher
- Smart Home Student
- Smart Home Power Supply
- Door Shackle Brighty
- Door Shackle Click
- Cover Suit
- Cover TUX
- Smart Lock Rene
- Battery Lock LEO PIN
- Battery Lock LEO RFID
- Battery Pack Square
- Battery Pack Tall
- Battery Lock LEO Latch
- Battery Lock LEO Horizontal PIN
- Battery Lock LEO Horizontal RFID
- Battery Lock LEO IP65
- Payterm Contactless & PIN
- Payterm Contactless Only
- QR Reader IP65
- Lock Profile
- Advanced RFID Reader
- Basic RFID Reader
- Smart Lock 1.0
- Door Shackle Smart Lock 1.0
- Cover Smart Lock 1.0



Need support?

 +31 (085)-489 13 35

 support@keynius.eu