



■ PRODUCT DATASHEET

Smart Locker Cabinet VAULT.

Plug & Play Smart Locker Cabinets,
made from steel.

■ PRODUCT DATASHEET

Smart Locker Cabinet

VAULT

High-quality Smart Locker Cabinet, featuring reinforced “front-laying” doors, customizable dimensions, and eco-friendly construction. This storage solution is designed for both practicality and durability, making it an excellent choice for various spaces.

Our VAULT-line is specifically designed and manufactured in Europe.

- Versatile Design, Ideal for Modern Spaces
- Reinforced “Front-Laying” Doors for Enhanced Safety
- Customizable Dimensions
- Eco-Friendly Construction with High-Quality Steel Sheet

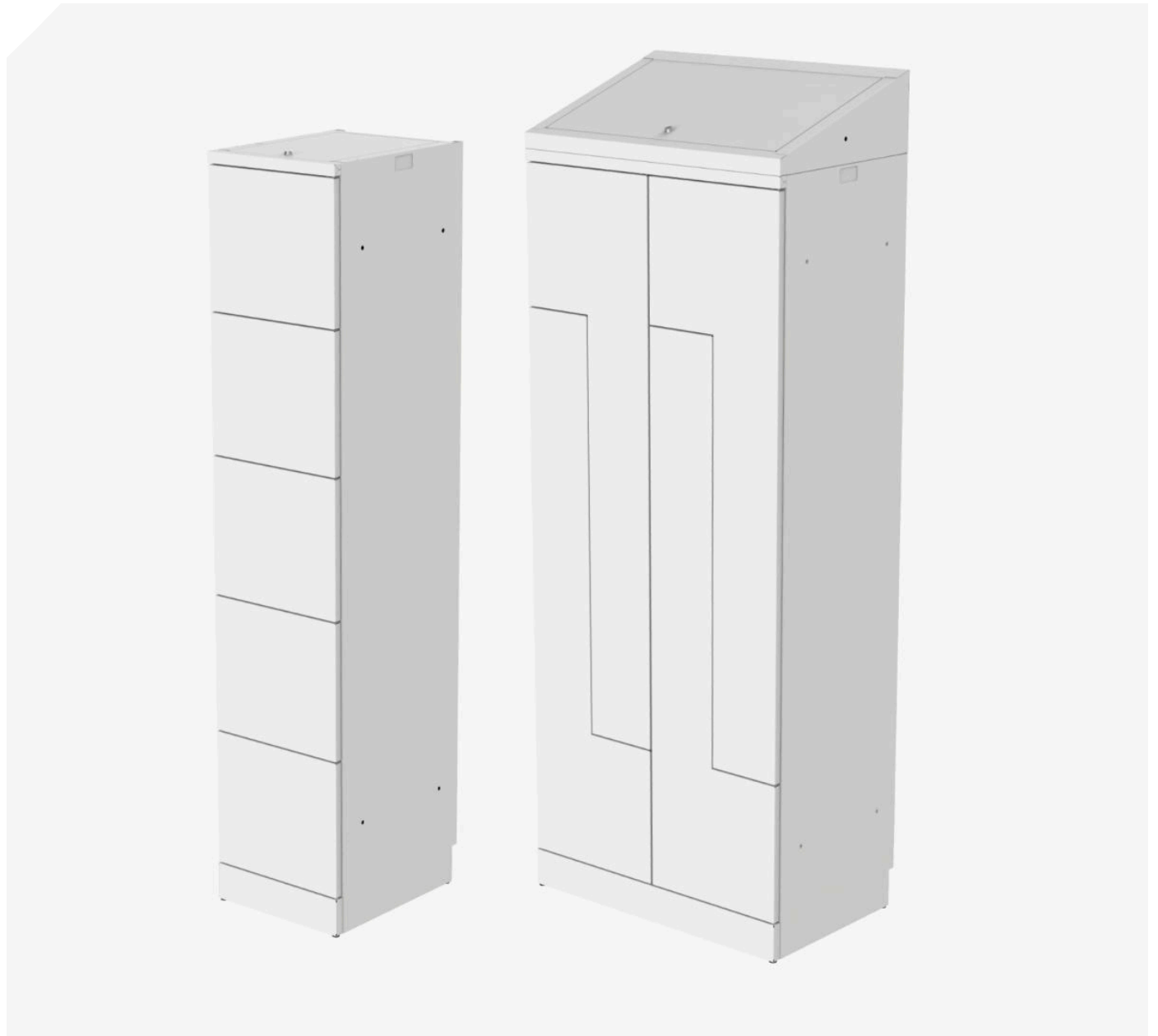

Technical Specifications

Our steel Smart Locker Cabinets are meticulously crafted with durability and versatility in mind, providing seamless storage solutions for a variety of environments.

Constructed from high-quality cold-rolled furniture sheet steel and finished with a scratch-resistant powder coating, these Smart Locker Cabinets offer unparalleled resilience.

Engineered with 4-fold closed profiles at the rear of the doors, they remain undeformable even under heavy use.

With versatile configurations available, our cabinets are designed to meet diverse storage needs, offering robust solutions for any space.

GENERAL

Compartments	Easy cleaning of the compartments due to smooth shelves without backsplash
Door design	Front laying doors. The back side of the door is reinforced with two vertical mounted, sealed overlapping profiles, for maximum strength
Material cabinet	High-quality steel sheet (0.8 mm)
Material doors	High-quality steel sheet (0.8 mm)
Single column empty weight	55 - 119 kg
Dual column empty weight	94 - 197 kg
Usability	All screws that can be seen by users are TORX
Intended use environment	Indoor
Shipping	Cabinets are individually packed for easy shipping placement

CABINET

Lacquering body	Environmentally friendly powder coating
Powder coat thickness	50 microns
Color	Based on standard RAL colors, see color range document
Cabinet texture	Matte, smooth finish

DOOR

Lacquering doors	Environmentally friendly powder coating
Powder coat thickness	50 microns
Color	Based on standard RAL colors, see color document
Door front texture	Matte, smooth finish
Opening direction	Right opening
Reinforced stainless steel pin hinge	Integrated stainless steel pin

BASE

Base steps

A small step is created in the base on the back to allow for installation against walls with a baseboard (plinth)

Leveling feet

Every base is delivered with pre-installed adjustable feet

**DETAILED
SPECIFICATION**



Top door



Easy lock replacement

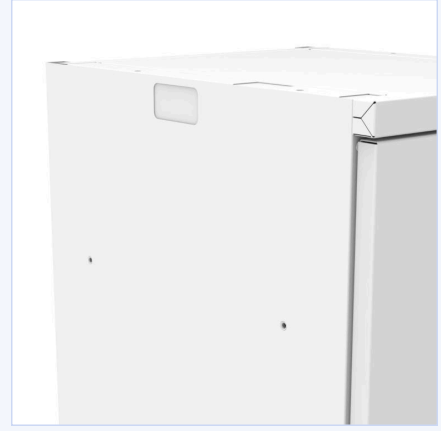

Cabinet connection holes

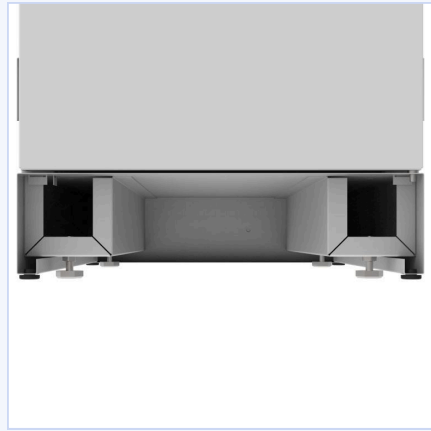

Adjustable feet

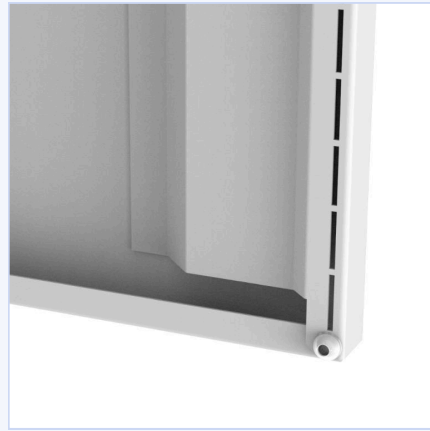

Silicone doorstop

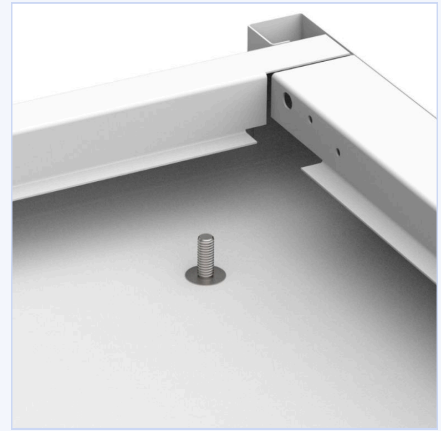

Grounding rod



Mechanical emergency opening

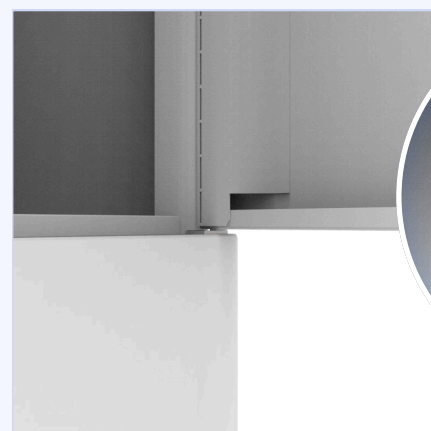
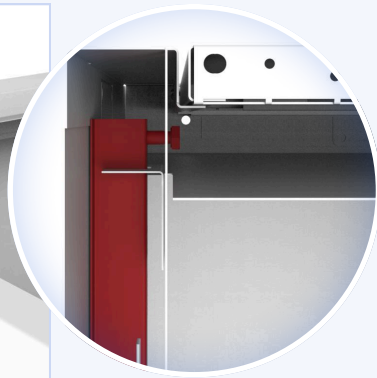

Integrated hinges

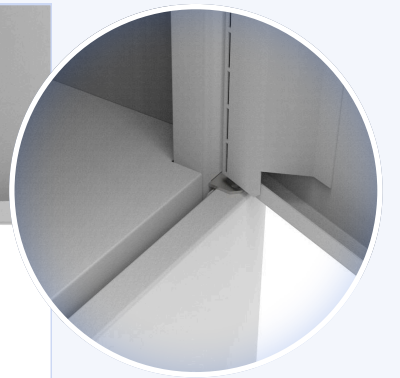

Cover for cable management hole



■ PRODUCT DATASHEET

Locking Technology

Storing personal and company belongings has been very important for many years. Nowadays it is also essential that this can be done quickly, easily, safely and with due regard for privacy. The storage options are endless and can be fully adapted to the wishes of the users.



Smart Lock René

The game changer in the smart locking industry. Possibility to use as both push2open and pop2open. In case of a power shutdown, the mechanical emergency override will make sure lockers can still be opened.

- 2 ways of cable connection
- Mechanical emergency opening
- Cabinet mount or profile mount
- Push- & Pop2open by software
- Plug & Play
- Easy to install



Smart Home Teacher V3

The compact designed Smart Homes are the backbones of our smart locking system. Easy to install and connect, with up to 16 locks per unit. The Smart Home Teacher is the basis and can control up to 13 Smart Home Students, operating 224 locks in total.

- Plug & Play
- Connect up to 13 Students on 1 teacher
- Open all locks emergency opening
- Connect Smart Lock René + Add-ons
- Status LEDs
- LAN

■ PRODUCT DATASHEET

Locker Cabinets

Our Steel Smart Locker Cabinets are available in two models: Standard and Sloping Top. The visual below shows the differences between the models, as well as the similarities.

The internal dimensions per locker are equal for all models. Only the technical compartment and the resulting total height of the locker cabinet is different.

Standard model
(Default)

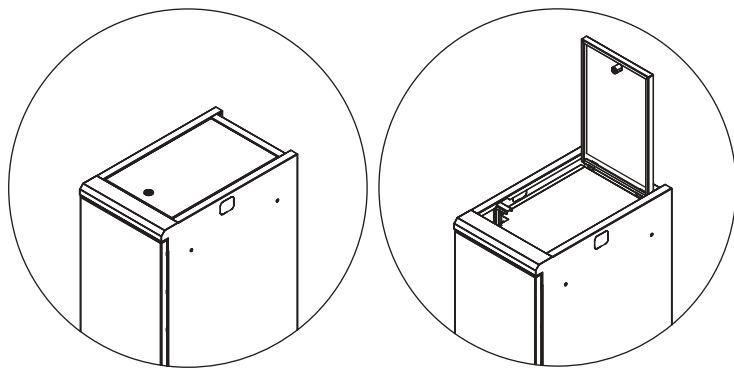

Sloping top model
(Accessory)

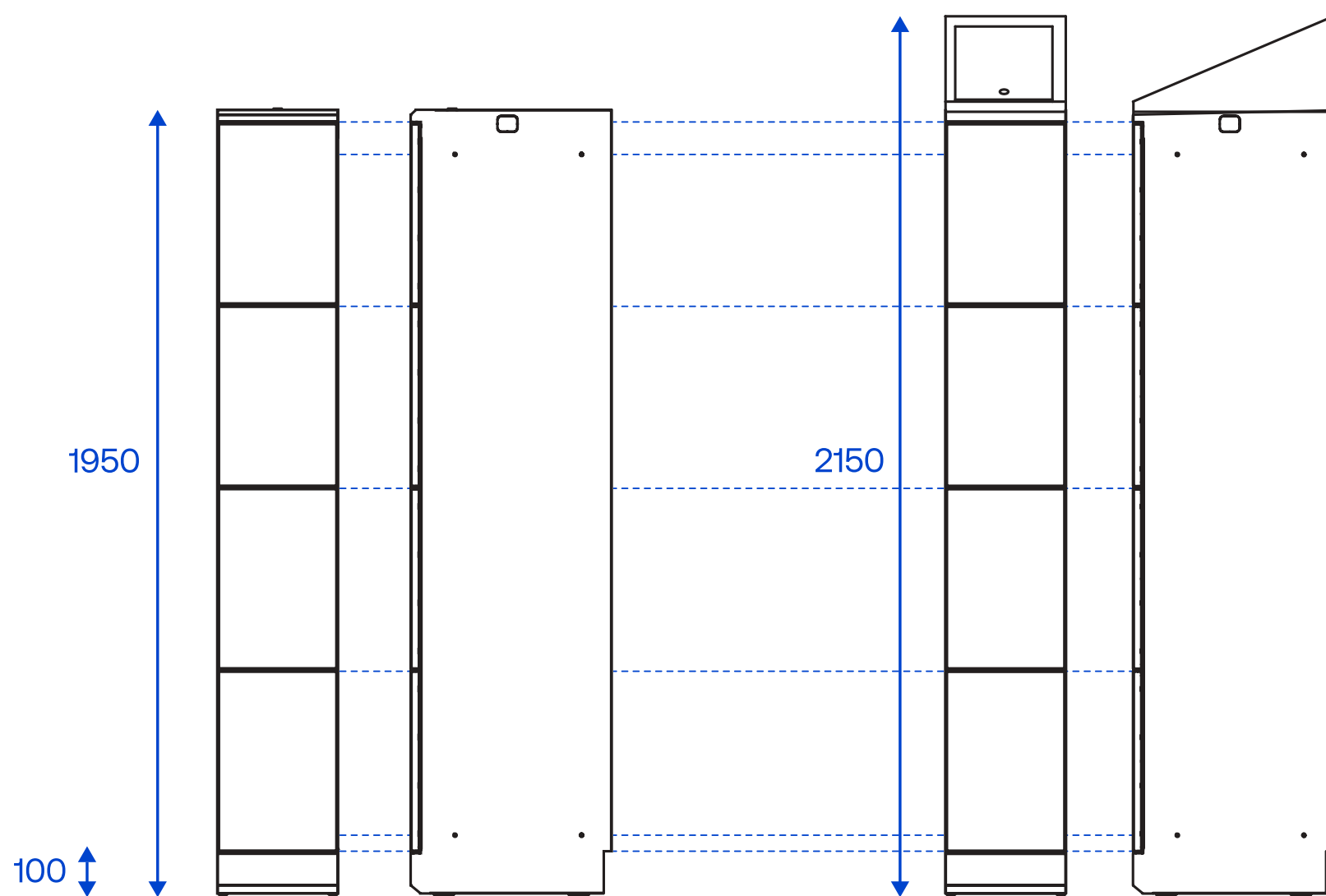
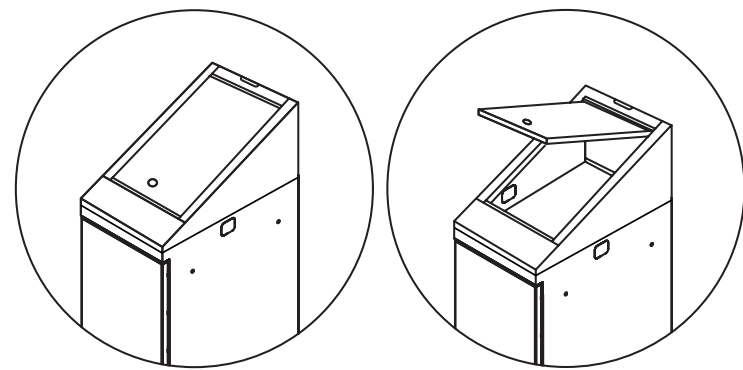



■ PRODUCT DATASHEET

Dimensions

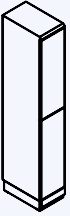
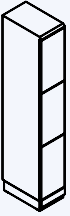
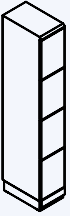
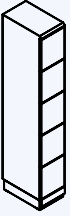

Our steel Smart Locker Cabinets are available in a range of sizing options to accommodate diverse storage needs.

Select from various configurations, including one or two columns with 1-10 doors per column, for tailored storage solutions.

ONE COLUMN

	Column	Lockers	Total height	Internal height per locker*	Width	Internal width per locker*	Depth	Internal depth per locker*
	1	1	1950 mm	1800 mm	300 mm 400 mm	234 mm 334 mm	500 mm	454 mm
	1	2	1950 mm	890 mm	300 mm 400 mm 500 mm	234 mm 334 mm 434 mm	500 mm 650 mm 850 mm	454 mm 604 mm 804 mm
	1	3	1950 mm	587 mm	300 mm 400 mm 500 mm	234 mm 334 mm 434 mm	500 mm 650 mm 850 mm	454 mm 604 mm 804 mm
	1	4	1950 mm	435 mm	300 mm 400 mm 500 mm	234 mm 334 mm 434 mm	500 mm 650 mm 850 mm	454 mm 604 mm 804 mm
	1	5	1950 mm	344 mm	300 mm 400 mm	234 mm 334 mm	500 mm	454 mm
	1	6	1950 mm	283 mm	300 mm 400 mm	234 mm 334 mm	500 mm	454 mm

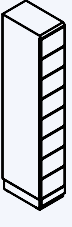
ONE COLUMN

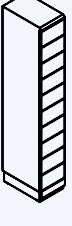
	Column	Lockers	Total height	Internal height per locker*	Width	Internal width per locker*	Depth	Internal depth per locker*
	1	7	1950 mm	240 mm	300 mm 400 mm	234 mm 334 mm	500 mm	454 mm
	1	8	1950 mm	208 mm	300 mm 400 mm	234 mm 334 mm	500 mm	454 mm
	1	9	1950 mm	182 mm	300 mm 400 mm	234 mm 334 mm	500 mm	454 mm
	1	10	1950 mm	162 mm	300 mm 400 mm	234 mm 334 mm	500 mm	454 mm

* Sizes are shown as average sizes and may deviate in real life.

TWO COLUMN

	Column	Lockers	Total height	Internal height per locker*	Width	Internal width per locker*	Depth	Internal depth per locker*
	2	1	1950 mm	1800 mm	600 mm 800 mm	234 mm 334 mm	500 mm	454 mm
	2	2	1950 mm	890 mm	600 mm 800 mm	234 mm 334 mm	500 mm	454 mm
	2	3	1950 mm	587 mm	600 mm 800 mm	234 mm 334 mm	500 mm	454 mm
	2	4	1950 mm	435 mm	600 mm 800 mm	234 mm 334 mm	500 mm	454 mm
	2	5	1950 mm	344 mm	600 mm 800 mm	234 mm 334 mm	500 mm	454 mm
	2	6	1950 mm	283 mm	600 mm 800 mm	234 mm 334 mm	500 mm	454 mm
	2	7	1950 mm	240 mm	600 mm 800 mm	234 mm 334 mm	500 mm	454 mm
	2	8	1950 mm	208 mm	600 mm 800 mm	234 mm 334 mm	500 mm	454 mm

TWO COLUMN

	Column	Lockers	Total height	Internal height per locker*	Width	Internal width per locker*	Depth	Internal depth per locker*
	2	9	1950 mm	182 mm	600 mm 800 mm	234 mm 334 mm	500 mm	454 mm
	2	10	1950 mm	162 mm	600 mm 800 mm	234 mm 334 mm	500 mm	454 mm

* Sizes are shown as average sizes and may deviate in real life.

■ PRODUCT DATASHEET

Interior Accessories

Enhance the functionality and customization of your VAULT Smart Locker Cabinet with our range of accessories.

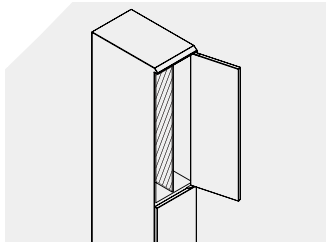

Vertical Partitions

Divide locker compartments efficient organization and segregation of contents.

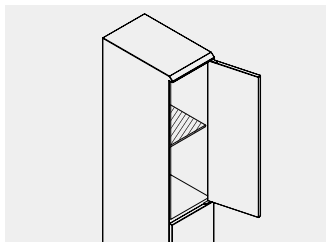

Additional shelves

Increase storage capacity and organization with durable shelves.

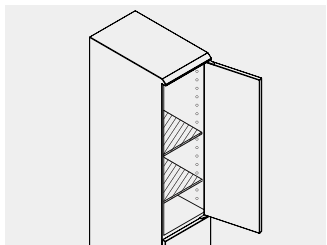

Height adjustable shelf

Experience customizable compartment with height adjustable (white) shelves to increase the storage capacity even more.

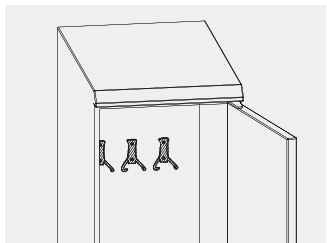

Clothing hook(s)

Steel functional clothing hook with two hanging points.

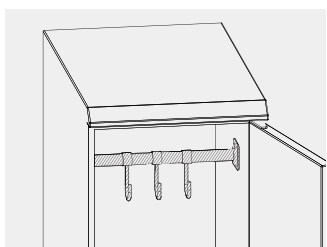

Clothing rod with 3 hooks

20 mm bar for clothing hangers. Comes with 3 hooks that can be divided along the rod according to your wishes.

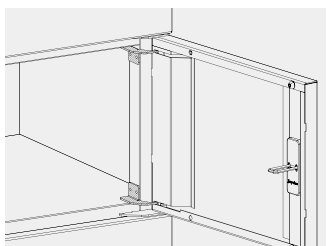

Door limiter

Steel Door Limiter integrated into the cabinet. Will limit the door rotation to a maximum angle of 95 degrees.

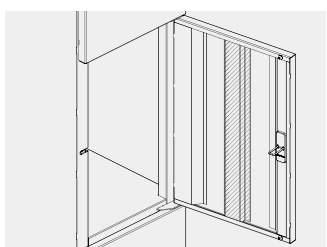

Reinforced door

This bended steel shape will be integrated with the door which enhances its stiffness and durability.

■ PRODUCT DATASHEET

Exterior Accessories

Enhance the functionality and customization of your VAULT Smart Locker Cabinet with our range of accessories.

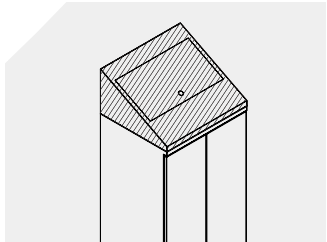

Sloping top

Prevent clutter accumulation and provide a sleek aesthetic finish to your locker cabinet setup.

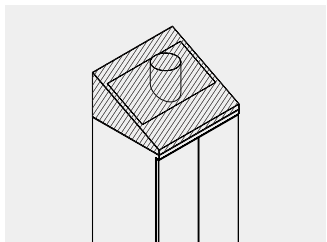

Sloping top with ventilation preparation

Mechanical ventilation can be directly connected to this sloping top, allowing a non-stop refreshment of the cabinets.

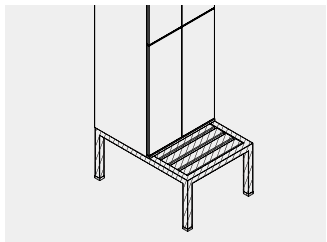

Integrated bench (no base/plinth)

Maximize space efficiency by integrating lockers with a bench underneath, providing convenient seating and storage solutions.

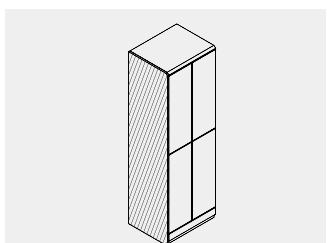

Side panels (left and right)

Finish your cabinets with some aesthetically pleasing side panels to create a unified locker wall.

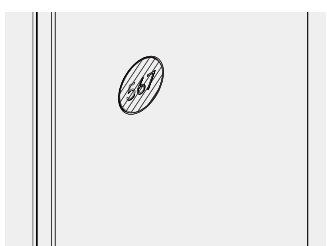

Numbering plate aluminium (flush)

Simplify locker management with this circular number plate (Ø 50mm) made out of aluminium. The plate will be integrated in the door and leaves a smooth and flush surface. Available in colours: Black, Gold, Red, Green and Blue.

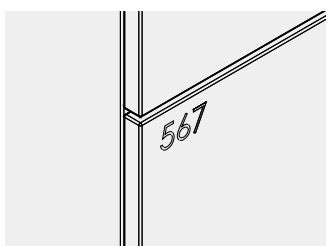

Numbering sticker

This sticker can be placed directly on the door for simplified locker management. Available in colours: Black, Silver/grey and white.

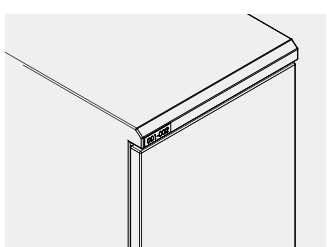

Column number plate basic

Simplify locker management with this clear long-lasting labelling for your columns. Available in colours: White, Black or 'Aluminium'-look.

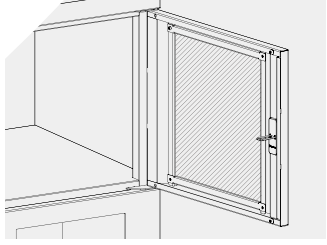

Transparent doors

The full cabinet will be provided with transparent (Plexiglass) doors, allowing the user to have a view on the inside of the door without opening it. The Plexiglass plate is 6mm thick.

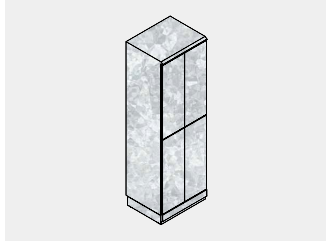

Zincor (Body + doors)

The entire cabinet including doors will be forged from Zincor steel. Zincor steel is ideal for cabinet lockers due to its durability and corrosion resistance, ensuring long-lasting performance with minimal maintenance.

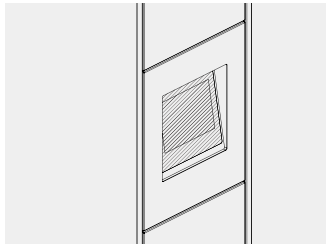

Angled Terminal screen

Angled terminal screens in a smart locker cabinet enhance user ergonomics and visibility, making interactions more intuitive and accessible. The Terminal screen will be placed under an angle of 10 degrees.

■ PRODUCT DATASHEET

Technology Accessories

Enhance the functionality and customization of your VAULT Smart Locker Cabinet with our range of accessories.



Smarty 8 inch touch screen

Extensive operating options for a locker, just within reach. This Smarty touch screen offers extensive options for both users and administrators: access via RFID or PIN code and login functionalities and developing scenarios for administrators. The perfect solution if space on the locker is limited.



Smarty 15 inch touch screen

Extensive operating options for a locker, just within reach. This Smarty touch screen offers extensive options for both users and administrators: access via RFID or PIN code and login functionalities and developing scenarios for administrators. The perfect solution if there is a need for a large screen.



Payment terminal contactless and PIN

A multifunctional payment terminal that is optimally suited for unattended environments, both indoors and outdoors. This terminal has a camera for scanning barcodes, an antenna for cellular communication and a pre-installed SIM card. This payment terminal allows users to pay quickly and securely with a debit card or mobile wallet.



QR reader IP66

Access control has never been easier thanks to this QR reader. This QR reader can easily be connected to Keynius products with a USB connection. Seamless integration then ensures an optimal user experience for both users and administrators. The IP66 certification makes this QR reader weatherproof and ideal for outdoor use.

Data sheets that are also available:

- Smarty 8 inch
- Smarty 10 inch
- Smarty 15 inch
- Smarty Headless
- RFID Reader panel
- Smart Home Teacher
- Smart Home Student
- Smart Home Power Supply
- Door Shackle Brighty
- Door Shackle Click
- Cover Suit
- Cover TUX
- Smart Lock Rene
- Battery Lock LEO PIN
- Battery Lock LEO RFID
- Battery Pack Square
- Battery Pack Tall
- Battery Lock LEO Latch
- Battery Lock LEO Horizontal PIN
- Battery Lock LEO Horizontal RFID
- Battery Lock LEO IP65
- Payterm Contactless & PIN
- Payterm Contactless Only
- QR Reader IP65
- Lock Profile
- Advanced RFID Reader
- Basic RFID Reader
- Smart Lock 1.0
- Door Shackle Smart Lock 1.0
- Cover Smart Lock 1.0



Need support?

 +31 (085)-489 13 35

 support@keynius.eu